



**EFFECTIVE FROM
JANUARY 2024**

EXPORT CATALOGUE
MISCELLANEOUS
AND ORIGINAL ACCESSORIES



REL. NOVEMBER 2024

COLOR TABLE

- 1) The standard company colour of our equipment is blue RAL 5015 (→ /25).
- 2) On demand other colours are available (see RAL table)*.

• Below the table for the colors:

	→ /25	RAL 5015 Blue sky
	→ /A4	RAL 5011 Blue (Peugeot)
	→ /22	RAL 5011 Blue (Peugeot) orange-peel
	→ /16	RAL 3002 Red
	→ /45	RAL 1003 Yellow (Renault)
	→ /38	RAL 7042 Grey (Renault)
	→ /39	RAL 7040 Window grey (Volkswagen / Porsche / Fiat)
	→ /33	RAL 7011 Grey (Mercedes)
	→ /65	RAL 7012 Grey (Mercedes)
	→ /52	RAL 7015 Grey (Mercedes)
	→ /69	RAL 7030 Stone grey (Ferrari / Maserati)
	→ /34	RAL 7016 Anthracite grey (BMW)

• Different colors subject to confirmation of the Export dept.

* : The equipment in different color than standard can be subject to surcharge.

The pictures included in the present illustrated catalogue, are only intended to show the product and are therefore not binding. The company reserves the right to make in every moment and without prior notice, any modification deemed necessary.

NEXION S.p.A.

Declines any responsibility for any complaint coming from the use of not original accessories or spares with consequent forfeiture of the CE conformity declaration.

TABLE OF CONTENTS

VULCANIZERS	4
SP 12	4
SP SERIES	4
SP 23	4
SP 32	4
SP 43	4
SP 54	4
SP 54/L	4
TYRE TEST TANKS	5
TT 18	5
TT 24	5
TYRE SPREADERS	6
TS 175	6
NITROGEN GENERATORS	7
NG 300	7
NG 500	7
NG 1800	7
OPTIONAL ACCESSORIES FOR NITROGEN GENERATORS	8
A/C DIAGNOSIS & RECHARGE STATIONS	9
A/C 1100 SERIES	9
A/C 1105 SERIES	10
A/C 1600 SERIES	11
A/C 1605 SERIES	12
OPTIONAL ACCESSORIES FOR A/C DIAGNOSIS & RECHARGE STATIONS	13
WHEEL WASHERS	14
W 850	14
OPTIONAL ACCESSORIES FOR WHEEL WASHER	15
AUXILIARY WHEEL LIFTERS	16
PARTNER 70	16
DIAGRAM OF PACKING SPECIFICATION	17
GENERAL SALE CONDITIONS	20

VULCANIZERS



SP SERIES



Main features:
 SP 12
 For inner tubes.
 SP 23 - SP 32
 For inner tubes and light-weight tyres (sidewalls).
 SP 43
 For vulcanization of inner tubes and any tyre in any position.
 SP 54
 Portable vulcanizer with quick mechanical closure. Designed for on-the-spot repair of heavy-duty vehicle.
 SP 54/L
 Same features as SP 54 vulcanizer. Heating plates are bigger and more powerful.

All models supplied with:
 1 Operator's manual.



SP SERIES

PN	Power Supply	Description
0-5100300101	230V/1Ph/50-60Hz	SP 12 - Vulcanizer with quick mechanical closure.
0-5100300201	110V/1Ph/60Hz	SP 12 - Vulcanizer with quick mechanical closure.
0-5100310101	230V/1Ph/50-60Hz	SP 23 - Vulcanizer with pneumatic closure.
0-5100320101	230V/1Ph/50-60Hz	SP 32 - Vulcanizer with pneumatic closure.
0-5100330101	230V/1Ph/50-60Hz	SP 43 - Vulcanizer with pneumatic closure.
0-5100340101	230V/1Ph/50-60Hz	SP 54 - Vulcanizer with quick mechanical closure.
0-5100350101	230V/1Ph/50-60Hz	SP 54/L - Vulcanizer with quick mechanical closure.



: New or Modified Item

TYRE TEST TANKS



TT SERIES



All models supplied with:
1 Operator's manual.



TT SERIES

PN	Power Supply	Description
0-5300320001		TT 18 Air-operated with 6/8 bar operating pressure, complete with wheel holder lifting and lowering control. Maximum wheel diameter 800 mm. Maximum wheel width 320 mm.
0-5300310001		TT 24 Complete with air filter, air-operated with 8 bar operating pressure. Maximum wheel diameter 1300 mm. Maximum wheel width 500 mm.



 : New or Modified Item

TYRE SPREADERS



TS 175



Main features:
Electropneumatic tyre spreader to handle any type of tyre from 10" to 17.5".



All models supplied with:
1 Operator's manual.



TS 175

PN	Power Supply	Description
0-5200300101	230-400V/3Ph/50Hz	TS 175

OPTIONAL ACCESSORIES FOR TS 175

PN	Picture	Description
805491445		TS ASP Pneumatic dust extractor.
805491444		TS SMER Pneumatic grinder.



 : New or Modified Item

NITROGEN GENERATORS



NG SERIES



NG 300



NG 500



NG 1800

Main features:

NG 300

Capacity: 3,0 Nm³/h (3.000 l/h).

Dedicated for the inflation of car, van and motorcycle tyres.

Integrated high capacity tank (100 l.) in order to reduce the nitrogen.

NG 500

Capacity: 5,0 Nm³/h (5.000 l/h).

Dedicated for the inflation of car, van and motorcycle tyres.

Integrated high capacity tank (100 l.) in order to reduce the nitrogen.

NG 1800

Capacity: 18,0 Nm³/h (18.000 l/h).

Professional nitrogen generator dedicated for inflating truck, bus, earth moving machine and car wheels.

All models supplied with:
1 Operator's manual.











PN	Power Supply	Description
0-55201200/25		NG 300 - Capacity 3,0 Nm ³ /h (3000 l/h).
0-55201300/25		NG 500 - Capacity 5,0 Nm ³ /h (5000 l/h)
0-55201600/25		NG 1800 - Capacity 18,0 Nm ³ /h (18.000 l/h).



: New or Modified Item

OPTIONAL ACCESSORIES FOR NITROGEN GENERATORS

PN	Picture	Description
8-53600000		Cyclonic condensate separator .
8-55600001		Pipes take-up (15 m.).
8-55600002		Professional inflating/deflating gun .
8-11100362		Tyre inflating gun with BAR scale. G1/4".
8-51120007		Tyre inflating gun with both BAR and PSI scales. G1/4".
8-11600127		Purity measuring kit .
8-55600023		Filter cartridges 3-5 Nm3/h.
8-55600024		Filter cartridges 18 Nm3/h.
8-55600025		Air contamination indicator .

A/C DIAGNOSIS & RECHARGE STATIONS



A/C 1100 SERIES



All models supplied with:
1 Operator's manual.



A/C 1100 SERIES

PN	Power Supply	Description
0-66500201/64	230V/1Ph/50-60Hz	A/C 1100 Air Conditioning recharging station, R-134a refrigerant only, manual and automatic functions, recovery-recycle-recharge, hybrid vehicle management, 192x64pixels LCD display, Wi-Fi/BT connection
0-66500601/64	230V/1Ph/50-60Hz	A/C 1100P Air Conditioning recharging station, R-134a refrigerant only, manual and automatic functions, recovery-recycle-recharge, hybrid vehicles management, 192x64pixels LCD display, Wi-Fi/BT connection, printer included



 : New or Modified Item

A/C DIAGNOSIS & RECHARGE STATIONS



A/C 1105 SERIES



All models supplied with:
1 Operator's manual.



A/C 1105 SERIES

PN	Power Supply	Description
0-66500301/64	230V/1Ph/50-60Hz	A/C 1105 Air Conditioning recharging station, R-1234yf refrigerant only, manual and automatic functions, recovery-recycle-recharge, hybrid vehicles management, 192x64pixels LCD display, Wi-Fi/BT connection
0-66500701/64	230V/1Ph/50-60Hz	A/C 1105P Air Conditioning recharging station, R-1234yf refrigerant only, manual and automatic functions, recovery-recycle-recharge, hybrid vehicle management, 192x64pixels LCD display, Wi-Fi/BT connection, printer included



 : New or Modified Item

A/C DIAGNOSIS & RECHARGE STATIONS



A/C 1600 SERIES



All models supplied with:
1 Operator's manual.



A/C 1600 SERIES

PN	Power Supply	Description
0-66500401/64	230V/1Ph/50-60Hz	A/C 1600 Fully automatic Air Conditioning recharging station, R-134a refrigerant only, manual and automatic functions, recovery-recycle-recharge, hybrid vehicles management, 7" 800x480pixels TFT-LCD RBG display , Wi-Fi/BT connection
0-66500801/64	230V/1Ph/50-60Hz	A/C 1600P Fully automatic Air Conditioning recharging station, R-134a refrigerant only, manual and automatic functions, recovery-recycle-recharge, hybrid vehicles management, 7" 800x480pixels TFT-LCD RBG display , Wi-Fi/BT connection, printer included



 : New or Modified Item

A/C DIAGNOSIS & RECHARGE STATIONS



A/C 1605 SERIES



All models supplied with:
1 Operator's manual.



A/C 1605 SERIES

PN	Power Supply	Description
0-66500501/64	230V/1Ph/50-60Hz	A/C 1605 Fully automatic Air Conditioning recharging station, R-1234yf refrigerant only, manual and automatic functions, recovery-recycle-recharge, hybrid vehicles management, 7" 800x480pixels TFT-LCD RBG display , Wi-Fi/BT connection
0-66500901/64	230V/1Ph/50-60Hz	A/C 1605P Fully automatic Air Conditioning recharging station, R-1234yf refrigerant only, manual and automatic functions, recovery-recycle-recharge, hybrid vehicles management, 7" 800x480pixels TFT-LCD RBG display , Wi-Fi/BT connection, printer included



 : New or Modified Item

OPTIONAL ACCESSORIES FOR A/C DIAGNOSIS & RECHARGE STATIONS

PN	Picture	Description
8-66500010		High/low pressure pipes kit , L=4,5 mt for, R1234yf refrigerant
8-66500011		High/low pressure pipes kit , L=4,5 mt, for R134a refrigerant
8-66500209		Leak detection kit with nitrogen/hydrogen 2.2.
6019000305		Leak detection kit only with UV lamps and glasses.

WHEEL WASHERS



W 850



Available versions:

- W 850 B (steel tank without heater)
- W 850 P (steel tank and heater)
- W 850 T (stainless steel tank and heater).



All models supplied with:

- 1 Granules collecting drawer.
- 15 kg of plastic granules.
- 1 Drain pipe (Ø50 mm.).
- 1 Airjet gauge
- 1 Operator's manual







W 850

PN	Power Supply	Description
0-55200800/25	230-400V/3Ph/50Hz	W 850 B (steel tank without heater).
0-55200700/25	230-400V/3Ph/50Hz	W 850 P (steel tank and heater).
0-55201500/25	230-400V/3Ph/50Hz	W 850 T (stainless steel tank and heater).
0-51200921/25	230V/3Ph/60Hz	W 850 T (stainless steel tank and heater).



 : New or Modified Item

OPTIONAL ACCESSORIES FOR WHEEL WASHER

PN	Picture	Description
8-51120005		Wheel Lifter.
8-51100063		Set of granules for filling and replacement (15 kg).
8-55600010		Non-foaming liquid detergent , 10 l.
8-55600018		Elbow fitting for water drainage.
8-55600019		Ball faucet for water drainage.
8-55600026	 x2	Dragging roller replacement kit.
8-55600027		Support roller replacement kit.

AUXILIARY WHEEL LIFTERS



PARTNER70



Main features:

BATTERY-OPERATED WHEEL LIFTER that helps you to easily and safely demount, move and mount the wheels of cars, SUVs and light transport vehicles weighing up to 70 kg.

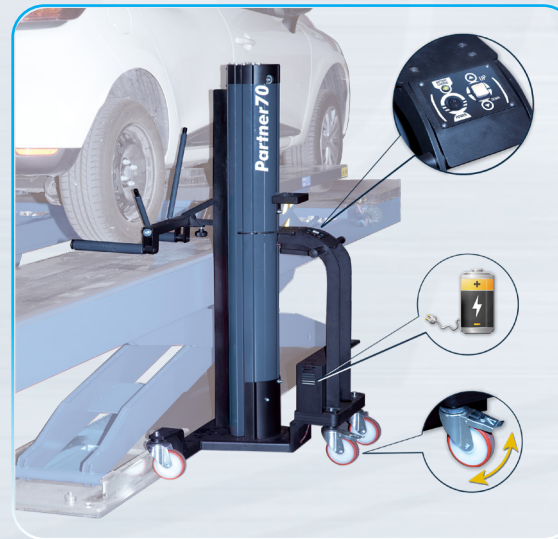

- AUTOMATIC
- AUTOMATIC
- SWIVEL WHEELS

All models supplied with:
1 Operator's manual.



PARTNER 70

PN	Power Supply	Description
8-21120021/64	24 V	PARTNER 70 - Battery-operated wheel lifter



 : New or Modified Item

DIAGRAM OF PACKING SPECIFICATION

MISCELLANEOUS EQUIPMENT

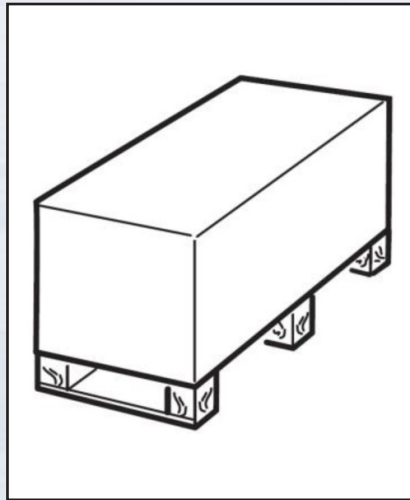

A

Model	Packing type	Dimensions (cm.) (A x B x H)	Net weight (kg)	Gross weight (kg)
VULCANIZERS				
SP 12	Carton box	41x 21x 56	8	10
SP 23 - SP 32 - SP 43	"	50x 23x102	27 / 27 / 29	32 / 32 / 34
SP 54 - SP 54/L	"	64x 30x100	29 / 31	33 / 35
TYRE TEST TANKS				
TT 16	Carton box on pallet (A)	95x 95x 74	68	80
TT 18	"	112x112x 92	100	115
TT 22.5	"	150x100x129	280	300
TYRE SPREADERS				
TS 175	Carton box on pallet (A)	75x 60x115	85	105
NITROGEN GENERATORS				
NG 300 - NG 500	Carton box on pallet (A)	72x 78x163	85 - 88	105 - 108
NG 1800	"	72x 78x163	52	72

Model	Packing type	Dimensions (cm.) (A x B x H)	Net weight (kg)	Gross weight (kg)
A/C DIAGNOSIS & RECHARGE STATIONS				
A/C 930L	Carton box on pallet (A)	65x 68x118	60	85
A/C 988	"	63x 56x111	65	90
A/C 989	"	63x 56x111	65	90
A/C 934L	"	65x 68x118	60	85
WHEEL WASHERS				
W 850	Carton box on pallet (A)	150x116x167	330	405



in the world

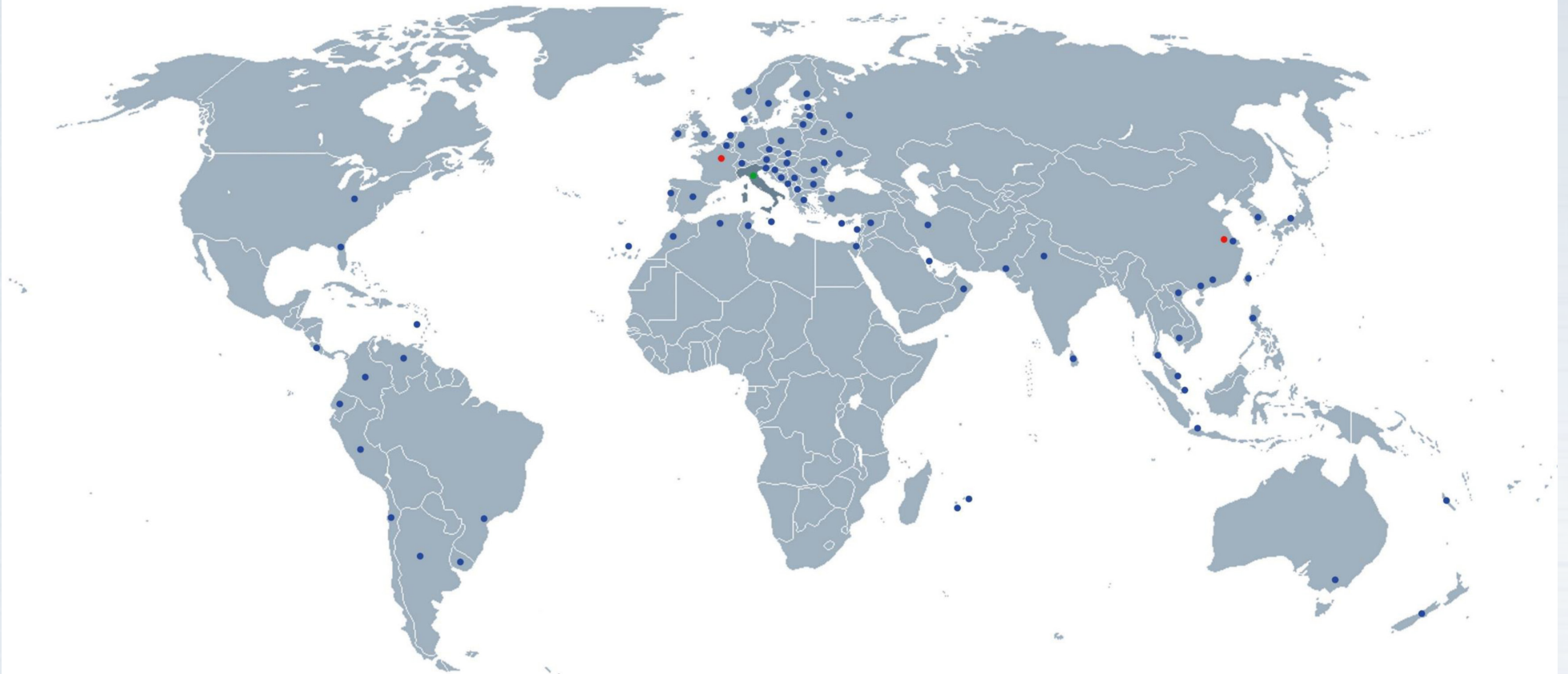

- : HPA-FAIP branch offices in the world.
- : HPA-FAIP distributors.
- : HPA-FAIP head office.

Sales and after-sales network:

- | | | | | | | | |
|-------------|------------------|-----------------|-------------|---------------------|---------------------|----------------------|-------------|
| ● ALGERIA | ● CAMBODIA | ● ECUADOR | ● INDIA | ● MACAO | ● NEW ZEALAND | ● RUSSIAN FEDERATION | ● TAIWAN |
| ● ARGENTINA | ● CANARY ISLANDS | ● ESTONIA | ● INDONESIA | ● MACEDONIA | ● NORWAY | ● SERBIA | ● THAILAND |
| ● AUSTRALIA | ● CHILE | ● FINLAND | ● IRAN | ● MALAYSIA | ● OMAN | ● SINGAPORE | ● TUNISIA |
| ● AUSTRIA | ● CHINA (RP) | ● FRANCE | ● IRELAND | ● MALTA | ● PAKISTAN | ● SLOVAK REPUBLIC | ● TURKEY |
| ● BAHRAIN | ● COLUMBIA | ● GERMANY | ● ISRAEL | ● MARTINICA | ● PERU | ● SLOVENIA | ● UKRAINE |
| ● BELGIUM | ● COSTA RICA | ● GREAT BRITAIN | ● JAPAN | ● MAURITIUS | ● PHILIPPINES (THE) | ● SPAIN | ● URUGUAY |
| ● BOSNIA | ● CROATIA | ● GREECE | ● KOSOVO | ● MONTENEGRO | ● POLAND | ● SRI LANKA | ● U.S.A. |
| ● BRAZIL | ● CYPRUS | ● HONG KONG | ● LATVIA | ● MOROCCO | ● PORTUGAL | ● SWEDEN | ● VENEZUELA |
| ● BULGARIA | ● CZECH REPUBLIC | ● HUNGARY | ● LEBANON | ● NETHERLANDS (THE) | ● REUNION ISLAND | ● SWITZERLAND | ● VIETNAM |
| ● CAMBODIA | ● DENMARK | ● KOREA (SOUTH) | ● LITHUANIA | ● NEW CALEDONIA | ● ROMANIA | ● SYRIA | |



■ : New or Modified Item

GENERAL SALE CONDITIONS

- x2 • The present export price-list, covering standard production equipment, replaces all previous ones.
- Goods are delivered FCA WAREHOUSE CORREGGIO - Incoterms® 2010, ICC Paris and shipped at buyer's cost.
- Standard packing is included in the price of each product.
- When ordering please always state model, quantity, power supply (Voltage, Phases, Hz) required.
- Terms of warranty: 12 months from installation date but no longer than 18 months from the date of NEXION S.p.A. invoice.
- The warranty does not cover defects or damages due to improper installation or use of products, inadequate maintenance or uncomplete knowledge of manuals supplied with the products.
- Any return of goods must always be authorized by NEXION S.p.A. and will be accepted only free our factory, custom cleared. Freight is at sender's risk.
- NEXION S.p.A. reserves the right to change the specifications of the products at any time without prior notice or obligation.

WARNING!

For other conditions please refer to the "Distribution Agreement".



 : New or Modified Item

- Compatible accessory supplied as STANDARD.
- Compatible accessory supplied on REQUEST.



**COMPANY WITH
CERTIFIED
QUALITY SYSTEM
- ISO 9001-**

