



**IN VIGORE DA
GENNAIO 2024**

**Bravo
LINE**

**Bravo
LINE**

**Bravo
LINE**

**Bravo
LINE**

**Bravo
LINE**

**Bravo
LINE**

CATALOGO ITALIA

BRAVO LINE

**SMONTAGOMME & EQUILIBRATRICI
E ACCESSORI ORIGINALI**

ED. SETTEMBRE 2024

INDICE

- 1) Il colore standard delle ns. attrezzature è il GRIGIO FINESTRA RAL 7040 (→ /39).
- 2) A richiesta è possibile avere le attrezzature con colori diversi (vedi tabella colori RAL) *.

• Di seguito la tabella per colori:

	→ /25 RAL 5015 Blu cielo
	→ /A4 RAL 5011 Blu (Peugeot)
	→ /22 RAL 5011 Blu (Peugeot) bucciato
	→ /16 RAL 3002 Rosso
	→ /45 RAL 1003 Giallo (Renault)
	→ /38 RAL 7042 Grigio (Renault)
	→ /39 RAL 7040 Grigio finestra (Volkswagen / Porsche / Fiat)
	→ /33 RAL 7011 Grigio (Mercedes)
	→ /65 RAL 7012 Grigio (Mercedes)
	→ /52 RAL 7015 Grigio (Mercedes)
	→ /69 RAL 7030 Grigio pietra (Ferrari / Maserati)
	→ /34 RAL 7016 Grigio antracite (BMW)

• Colorazioni differenti subordinate a conferma dell'Ufficio Commerciale.

*: L'attrezzatura in colore diverso da quello standard può essere soggetta ad eventuale sovrapprezzo.

Le immagini contenute nel presente stampato hanno il solo scopo di presentare il prodotto e pertanto non sono vincolanti. La ditta si riserva il diritto di apportare, in qualsiasi momento e senza preavviso, le modifiche che ritenesse utili.

La NEXION S.p.A. declina ogni responsabilità in caso di reclami derivanti dall'uso di accessori o ricambi non originali con conseguente decadenza della dichiarazione CE di conformità..

SMONTAGOMME LEGGERI TRADIZIONALI	4
M 54 LL	4
M 54	6
M 51	8
M 31	10
ACCESSORI A RICHIESTA PER SERIE M 54 E M 51	11
ACCESSORI A RICHIESTA PER SERIE M 31	12
ACCESSORI A RICHIESTA PER SERIE M 54 - M 51 - M 31	13
SMONTAGOMME PESANTI	17
F 440	17
F 426	18
ACCESSORI A RICHIESTA PER F 440 E F 426	19
EQUILIBRATRICI A BANCO UNIVERSALI	21
B 75	21
ACCESSORI A RICHIESTA PER B 75 TRUCK	22
EQUILIBRATRICI A BANCO VEICOLI LEGGERI	25
B 55	25
B 60	26
ACCESSORI A RICHIESTA PER B 55 E B 60	27
TABELLA PESI DIMENSIONI IMBALLI MACCHINE	31
CONDIZIONI GENERALI DI VENDITA	32

SMONTAGOMME LEGGERI TRADIZIONALI



M 54 LL SERIE



HTB24 Helper a richiesta



Tutti i modelli completi di:
 Parabordo
 Premitalone
 Spatola
 Serie di 4 protezioni griffe per cerchi in lega
 Guaina in plastica per paletta stallonatore
 Kit di inserti plastici per torretta
 Contenitore grasso lubrificante
 Supporto contenitor grasso
 Pennello per lubrificante talloni
 Manuali istruzioni

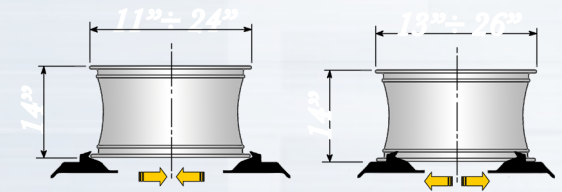

M 54 LL

Codice	Alimentazione	Descrizione
0-11901701/25	400V/3Ph/50Hz	M54 LL
0-11901712/25	200÷230V/1Ph/50Hz	M54 LL
0-11901722/25	200÷230V/1Ph/60Hz	M54 LL
0-11901711/25	400V/3Ph/50Hz	M54 LL FS

SMONTAGOMME LEGGERI TRADIZIONALI

Codice	Alimentazione	Descrizione
0-11901732/25	200÷230V/1Ph/50Hz	M54 LL FS
0-11901742/25	200÷230V/1Ph/60Hz	M54 LL FS
0-11901751/25	200÷230V/3Ph/60Hz	M54 LL FS
0-11901721/25	400V/3Ph/50Hz	M54 LL 2V
0-11901731/25	400V/3Ph/50Hz	M54 LL 2V FS
8-11220014		kit di personalizzazione - M54 LL

SMONTAGOMME LEGGERI TRADIZIONALI



M 54 SERIE



HTB24 Helper a richiesta



- Tutti i modelli completi di:
- 1 Leva alzatalloni + Guaina in plastica
 - 1 Serie di 4 protezioni griffe per cerchi in lega
 - 1 Guaina in plastica per paletta stallonatore
 - 1 Kit di inserti plastici per torretta
 - 1 Contenitore grasso lubrificante
 - 1 Supporto contenitor grasso
 - 1 Pennello per lubrificante talloni
 - 1 Manuali istruzioni

M 54

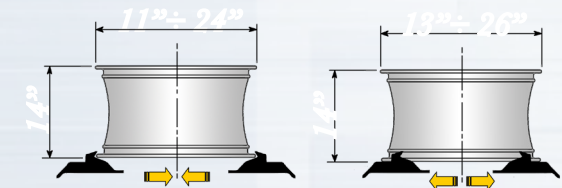

Codice	Alimentazione	Descrizione
0-11901331/25	400V/3Ph/50Hz	M 54 2V FS
0-11901321/25	400V/3Ph/50Hz	M 54 2V
0-11901311/25	400V/3Ph/50Hz	M 54 FS
0-11901332/25	200-230V/1Ph/50Hz	M 54 FS

SMONTAGOMME LEGGERI TRADIZIONALI

Codice	Alimentazione	Descrizione	
0-11901301/25	400V/3Ph/50Hz	M 54	
0-11901312/25	200-230V/1Ph/50Hz	M 54	
8-11220010		Kit personalizzazione per M 54	

SMONTAGOMME LEGGERI TRADIZIONALI



M 51 SERIE



HTB21 Helper a richiesta



- Tutti i modelli completi di:
- 1 Leva alzataloni + Guaina in plastica
 - 1 Serie di 4 protezioni griffe per cerchi in lega
 - 1 Guaina in plastica per paletta stallonatore
 - 1 Kit di inserti plastici per torretta
 - 1 Contenitore grasso lubrificante
 - 1 Supporto contenitor grasso
 - 1 Pennello per lubrificante talloni
 - 1 Manuali istruzioni

M 51

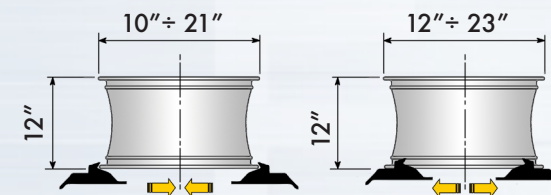

Codice	Alimentazione	Descrizione
0-11901431/25	400V/3Ph/50Hz	M 51 2V FS
0-11901421/25	400V/3Ph/50Hz	M 51 2V
0-11901411/25	400V/3Ph/50Hz	M 51 FS
0-11901432/25	200-230V/1Ph/50Hz	M 51 FS

SMONTAGOMME LEGGERI TRADIZIONALI

Codice	Alimentazione	Descrizione	
0-11901401/25	400V/3Ph/50Hz	M 51	
0-11901412/25	200-230V/1Ph/50Hz	M 51	
8-11220011		Kit personalizzazione per M 51	

SMONTAGOMME LEGGERI TRADIZIONALI



M 31

HTB21 Helper a richiesta



- Tutti i modelli completi di:
- 1 Leva alzataloni + Guaina in plastica
 - 1 Serie di 4 protezioni griffe per cerchi in lega
 - 1 Guaina in plastica per paletta stallonatore
 - 1 Kit di inserti plastici per torretta
 - 1 Contenitore grasso lubrificante
 - 1 Supporto contenitor grasso
 - 1 Pennello per lubrificante talloni
 - 1 Manuali istruzioni

M 31

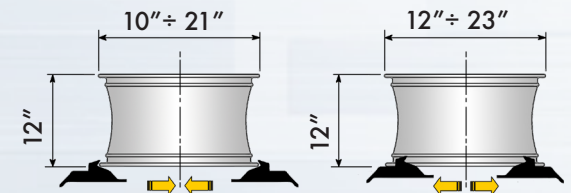

Codice	Alimentazione	Descrizione
0-11901501/25	400V/3Ph/50Hz	M 31
8-11220012		Kit personalizzazione per M 31

ACCESSORI A RICHIESTA PER SERIE M 54 E M 51

Codice	Immagine	Descrizione	M54 LL SERIE	M54 SERIE	M51 SERIE
8-11900260		HTB24 Accessorio universale alza/premitallone.	●	●	
8-11900261		HTB21 Accessorio universale alza/premitallone.	●	●	●

ACCESSORI A RICHIESTA PER SERIE M 31

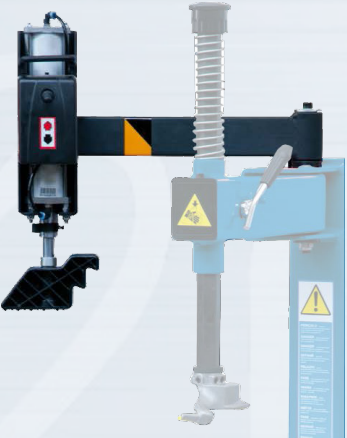
Codice	Immagine	Descrizione
8-11900262		HSA 21 Accessorio universale alza/premitallone.

ACCESSORI A RICHIESTA PER SERIE M 54 - M 51 - M 31

Codice	Immagine	Descrizione	M54LL 2V-M54LL	M54LL FS	M54 2V-M54	M54 FS	M51 2V-M51	M51 FS	M31
8-11120075		FWL 65 Sollevatore ruota	●	●	●	●	●	●	
CT-S-0600000		WRSB Base supporto ruota	●	●	●	●	●	●	●
8-11100342		PGA Pistola di gonfiaggio con manometro in BAR (Attac. baionetta - omologato CE)	●		●		●		●
CT-S-0200000		Utensile premitallone universale.	■	■	●	●	●	●	●
CT-S-0110000		Cambio rapido torretta.			●	●	●	●	●

ACCESSORI A RICHIESTA PER SERIE M 54 - M 51 - M 31

Codice	Immagine	Descrizione	M54LL 2V-M54LL	M54LL FS	M54 2V-M54	M54 FS	M51 2V-M51	M51 FS	M31
CT-S-0310002		Torretta in plastica senza attacco rapido.			●	●	●	●	●
CT-S-0310000		Torretta in plastica con attacco rapido.			●	●	●	●	●
C-21-8000100		Torretta per route moto			●	●	●	●	●
C-21-8000001		Protezione plastica per torretta route moto.			●	●	●	●	●
CT-S-0500000		Leva per pressare il pneumatico.	●	●	●	●	●	●	●

ACCESSORI A RICHIESTA PER SERIE M 54 - M 51 - M 31

Codice	Immagine	Descrizione	M54LL 2V-M54LL	M54LL FS	M54 2V-M54	M54 FS	M51 2V-M51	M51 FS	M31
C-M-0200000		kit di 4 adattatori moto per griffe regolabili internamente (11"-26")	●	●	●	●			
C-M-0200000A		kit di 4 adattatori moto per griffe regolabili internamente, (8"-23")					●	●	●
8-11900272		Kit protezioni in plastica per attacchi moto (kit 4+4)	●	●	●	●	●	●	●
C-M-0300000		4 Adattatori moto per cerchi con raggi ad alto profilo (es. BMW-Ducati) - (11"-26")	●	●	●	●			
C-M-0400000		4 Adattatori moto per cerchi con raggi ad alto profilo (es. BMW-Ducati) - (8"-23")						●	●
C-54-8000003		Leva alzatalloni.			●	●	●	●	●
C-54-8000019		Guaina in plastica per leva alzatalloni.			●	●	●	●	●
8-11900270		kit protezioni in plastica: sono incluse anche n. 8 protezioni da 21" e n. 8 protezioni da 24"			●	●	●	●	●
8-11900271		Kit protezioni in plastica leva e paletta	●	●	●	●	●	●	

ACCESSORI A RICHIESTA PER SERIE M 54 - M 51 - M 31

Codice	Immagine	Descrizione	M54LL 2V-M54LL	M54LL FS	M54 2V-M54	M54 FS	M51 2V-M51	M51 FS	M31
8-11900265	 x4	Kit di 4 protezioni in plastica da 24"	●	●	●	●			
8-11900268	 x4	Kit di 4 protezioni in plastica da 21"					●	●	●
8-11900267	x4 	kit di 4 protezioni in plastica per torretta			●	●	●	●	●
8-11900266	x4 	kit di 4 protezioni in plastica per torretta			●	●	●	●	●
8-11120081	 x10  x5  x15	Kit protezioni per torretta LL	●	●					

SMONTAGOMME PESANTI



F 440

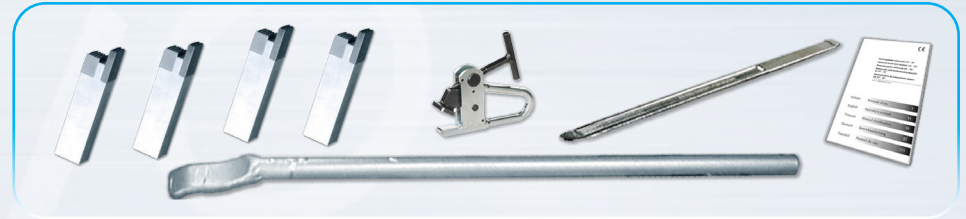

- Completo di:
- 1 Leva alzatalloni
 - 1 Leva per cerchiati
 - 1 Pinza per cerchiati
 - 1 Set di 4 estensioni da 40" a 56"
 - 1 Manuale istruzioni

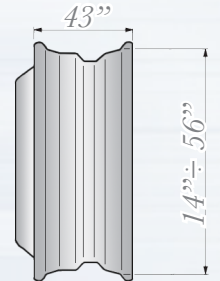

F 440

Codice	Alimentazione	Descrizione
0-12104301/39	400V/3Ph/50Hz	F 440 Grigio RAL 7040
8-12120014		Kit di personalizzazione per F 440

SMONTAGOMME PESANTI



F 426



- Completo di:
- 1 Leva alzatalloni
 - 1 Leva per cerchietti
 - 1 Pinza per cerchioni
 - 1 Set di 4 griffe per cerchi in lega
 - 1 Manuale istruzioni

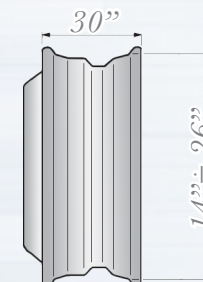



F 426

Codice	Alimentazione	Descrizione
0-12102101/53	400V/3Ph/50Hz	F 426 Grigio RAL 7004
8-12100146		Kit di personalizzazione F 426

ACCESSORI A RICHIESTA PER F 440 E F 426

Codice	Immagine	Descrizione
8-12120019		CGL56 Set di 4 griffe per cerchi in lega per F 440.
8-12100045		Kit inserti per protezioni cerchi in lega CGL56 per F 440
801271597		MV50/2 Coppia di morsetti con vite.
801227195		PL56 Pinza per cerchi in lega.
801217615		LA24 Leva alzatalloni.

ACCESSORI A RICHIESTA PER F 440 E F 426

Codice	Immagine	Descrizione
801417620		LC24 Leva per cerchietti.
8-12100005		AB164 Adattatore bloccaggio cerchi in lega D.164.
8-12100006		AB176 Adattatore bloccaggio cerchi in lega D.176.
8-12100007		AB161 Adattatore bloccaggio cerchi in lega D.161.
8-12100008		AB202 Adattatore bloccaggio cerchi in lega D.202.
8-12300001		AB220 Adattatore bloccaggio cerchi in lega D.220.
8-12100009		AB221 Adattatore bloccaggio cerchi in lega D.221.
8-12100010		AB281 Adattatore bloccaggio cerchi in lega D.281.

EQUILIBRATRICI A BANCO UNIVERSALI



B 75 TRUCK

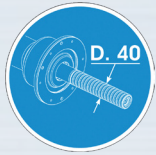

Modello completo di:

- 1 Calibro ruote
- 1 Chiave CH 12
- 1 Peso campione per autotaratura 300 gr.
- 1 Peso campione per autotaratura 100 gr.
- 1 Manuale istruzioni
- 1 Mozzo filettato con estrattore
- 1 Pinza fissaggio contrappesi

Protezione ruota e sollevatore ruota da 200 kg forniti di serie.

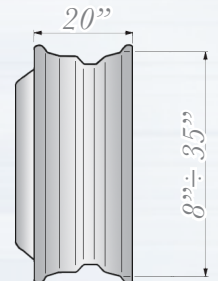

B 75

Codice	Alimentazione	Descrizione
0-21900026/39	200-230V/1Ph/50-60Hz	B 75 with Inverter Technology System (ITS)
8-21900184		Kit di personalizzazione B 75



: Particolare NUOVO o MODIFICATO

21

- : Accessorio compatibile fornito di serie
- : Accessorio compatibile fornito a richiesta

ACCESSORI A RICHIESTA PER B 75 TRUCK

Codice	Immagine	Descrizione
8-21900187/39		<p>CCKT - kit di personalizzazione colore (pannello in metallo) Il pannello CCK può essere acquistato nei seguenti colori:</p> <p>RAL 3002 Red /16 </p> <p>RAL 5002 Blue /20 </p> <p>RAL 5015 Blue Sky /25 </p> <p>RAL 7016 Gray /34 </p> <p>RAL 1007 Yellow /40 </p> <p>RAL 9005 Black /90 </p>
8-21900188		<p>L&L KIT Kit illuminatore LED e puntatore LASER lineare.</p>
8-21900220		<p>ART40 Gruppo flange d'equilibratura per ruote autocarro. Campo di lavoro: -PCD 5 x 225 - 285.75 - 335 mm. -PCD 4 x 275 - 285 mm.</p>
8-21900193	<p>FPC</p> 	<p>KCT40 Range 1: 211÷218 mm Range 2: 217÷224 mm Range 3: 277÷285 mm</p>

ACCESSORI A RICHIESTA PER B 75 TRUCK

Codice	Immagine	Descrizione
8-21100261		GGR40 Kit di centraggio diam. 40 per ruote con foro centrale 183,5÷223 mm, cerchi da 17,5" a 19,5" (IVECO - MAN - DAF)
8-21900189		ARFT40 Range 1: 95÷175 mm Range 2: 120÷133 mm Range 3: 144÷166 mm
8-21900191		ARU40 ø 42÷103,50 mm - molla incassata inclusa
8-21900194		GTV40 Ghiera fissaggio ruote.
8-21100275		GTR40 EVO PRO - Ghiera rapida di bloccaggio in acciaio Ø 40x4mm
8-21100276		GTR40 EVO - Ghiera rapida di bloccaggio Ø 40x4mm

ACCESSORI A RICHIESTA PER B 75 TRUCK

Codice	Immagine	Descrizione
8-21100290		TWS40 Distanziale ruote camion Ø 40 (30mm - 1.19")
8-21101402		Supporto accessori
8-21101403		KIT INDUSTRIA 4.0: Kit stand alone per la diagnosi dell'eccentricità radiale ruota collegabile alla rete aziendale dell'officina

EQUILIBRATRICI A BANCO VEICOLI LEGGERI

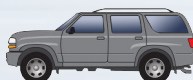

B 55



Pannello CCK
NON incluso



Modello completo di:
 1 Set di 4 coni $\varnothing 42 \div 156$ mm
 1 Pinza fissaggio contrappesi
 1 Ghiera rapida di serraggio
 1 Mozzo filettato
 1 Calibro ruote
 1 Calotta di fissaggio
 1 Peso da 100 g. per calibrazione
 1 Manuale istruzioni d'uso



B 55

Codice	Alimentazione	Descrizione
0-21900035/39	200÷230V/1Ph/50-60Hz	B55 M - Equilibratrice a display con acquisizione manuale dei dati, freno automatico a fine lancio (protezione ruota inclusa, kit di centraggio e bloccaggio incluso)
0-21900036/39	200÷230V/1Ph/50-60Hz	B55 AD - Equilibratrice a display con funzione AUTOSEL acquisizione automatica dei dati (distance & diameter 26"), freno automatico a fine lancio (protezione ruota inclusa, kit di centraggio e bloccaggio incluso)
8-21900203		Kit di personalizzazione per Bravoline B55

EQUILIBRATRICI A BANCO VEICOLI LEGGERI



B 60



Pannello CCK
NON incluso



Modello completo di:
 1 Set di 4 coni $\varnothing 42 \div 156$ mm
 1 Pinza fissaggio contrappesi
 1 Ghiera rapida di serraggio
 1 Mozzo filettato
 1 Calibro ruote
 1 Calotta di fissaggio
 1 Peso da 100 g. per calibrazione
 1 Manuale istruzioni d'uso



B 60

Codice	Alimentazione	Descrizione
0-21900038/39	200÷230V/1Ph/50-60Hz	B60 AD - Equilibratrice a Monitor con funzione AUTOSEL acquisizione automatica dei dati (distance & diameter 26"), freno automatico a fine lancio (protezione ruota inclusa, kit di centraggio e bloccaggio incluso, monitor NON incluso)
8-21900215		Kit di personalizzazione per Bravoline B60



ACCESSORI A RICHIESTA PER B 55 E B 60

Codice	Immagine	Descrizione	B 55 M	B 55 AD	B 60 AD
8-21100235		Monitor LCD 19" Widescreen per B 50.			●
8-21900206/25	 <p>CCK</p> <p>RAL 1003 3002 5002 5015</p>	CCK Pannello personalizz. colore: RAL 5015 Sky blue 	●	●	●
8-21900206/20		CCK Pannello personalizz. colore: RAL 5002 Blue 	●	●	●
8-21900206/16		CCK Pannello personalizz. colore: RAL 3002 Red 	●	●	●
8-21900206/45		CCK Pannello personalizz. colore: RAL 1003 Yellow 	●	●	●
8-21900207		PB NS - kit freno di stazionamento a pedale	●	●	●
8-21900209		TCE - 40 EVO Rilevatore larghezza esterno (solo per versioni con rilevatore interno automatico)		●	●

ACCESSORI A RICHIESTA PER B 55 E B 60

Codice	Immagine	Descrizione	B 55 M	B 55 AD	B 60 AD
8-21100238		LASER & LED kit	●	●	●
8-21100141		DX/CBF Accessorio centraggio per furgoni e fuoristrada. Comprende DX1 Distanziale CF1 Calotta furgoni D. 117÷147 CF2 Calotta furgoni D. 143÷173	Cod. 4-107426 4-107423 4-107424	●	●
8-21100082		SBC Kit di 6 boccole di centraggio post. (min. Ø 54 - max. Ø 75,4 mm). Comprende: B1 Boccola D. 56.5 ÷ 57.1 B2 Boccola D. 65 ÷ 67 B3 Boccola D. 73.2 ÷ 75.4 B4 Boccola D. 63.3 ÷ 64,2 B5 Boccola D. 58 ÷ 60.1 B7 Boccola D. 54÷56,1	Cod. 4-105075 4-105076 4-105077 4-105078 4-105079 4-105080	●	●
8-21100089		ARS Accessorio Racing per ruote sportive. Comprende: ARS Distanziale Racing DARS Distanziale 30 mm	Cod. 24732 4-105171	●	●
8-21100091		FRU-SA D.40 Flangia universale per tutte le ruote con o senza foro centrale. Comprende: FT1 Biella con perno DEB Dado bifronte fissaggio ruota CHI6 Chiave esagonale a T CH 6 CHI6 Chiave esagonale CH 6 CEP Chiave esagon. a pipa CH22 RFS Rilevatore interasse fori	Cod. 2401415 321878 4-10587 600906 426517 441286	●	●

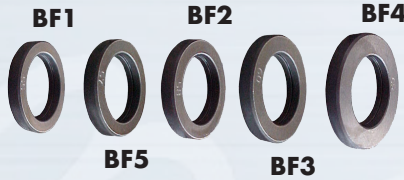
ACCESSORI A RICHIESTA PER B 55 E B 60

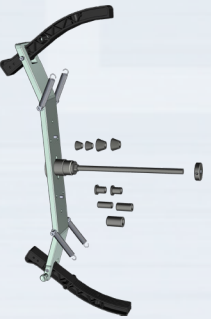
Codice	Immagine	Descrizione	B 55 M	B 55 AD	B 60 AD
8-21100092		BVFF Serie di 5 boccole per un preciso centraggio sulla flangia FRU. Comprende: BF1 Boccola D. 55 BF2 Boccola D. 58.1 BF3 Boccola D. 60.1 BF4 Boccola D. 65 BF5 Boccola D. 57 Cod. 4-105110 4-105174 4-105175 4-105176 4-106570	●	●	●
8-21900191		ARU40 ø 42÷103,50 mm - molla incassata inclusa	●	●	●
8-21100161		SL80 Sollevatore ruota pneumatico per equilibratrici.	●	●	●
8-21900210		BUK BASIC Kit universale di centraggio universale per ruote moto e scooter; già completo del kit SK14 cod. 8-21900228 (compatibile anche con BRAVOLINE B35) *Prolunga tastatore non inclusa	●	●	●

ACCESSORI A RICHIESTA PER B 55 E B 60





Codice	Immagine	Descrizione	B 55 M	B 55 AD	B 60 AD
8-21900225		PRA5 Prolunga tastatore	●	●	●
8-21900226		SK10 Albero moto \varnothing 10mm completo di coni di centraggio \varnothing 11-20 mm - \varnothing 11-20 mm, boccole e distanziale L=150 mm	●	●	●
8-21900227		SK12 Albero moto \varnothing 12mm completo di coni di centraggio \varnothing 13-24 mm , boccole e distanziale L=250 mm	●	●	●
8-21900228		SK14 Albero moto \varnothing 14mm completo di coni di centraggio \varnothing 15-25 mm - \varnothing 20-35 mm, boccole e distanziale L=250 mm (viene fornito anche con il kit BUK BASIC cod. 8-21900210)	●	●	●
8-21900229		SK19 Albero moto \varnothing 19mm completo di coni di centraggio \varnothing 21-51 mm, boccole e distanziale L=300 mm	●	●	●
8-21900224		PRA6 Prolunga tastatore (per BRAVOLINE B35)			

TABELLA PESI DIMENSIONI IMBALLI MACCHINE

ATTREZZATURE BRAVO LINE

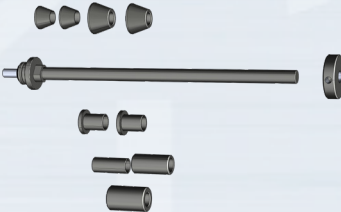
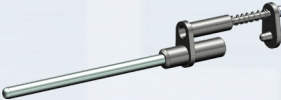
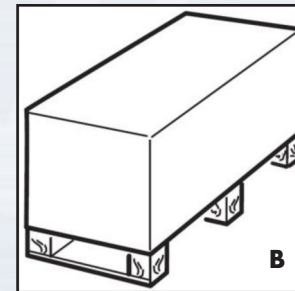
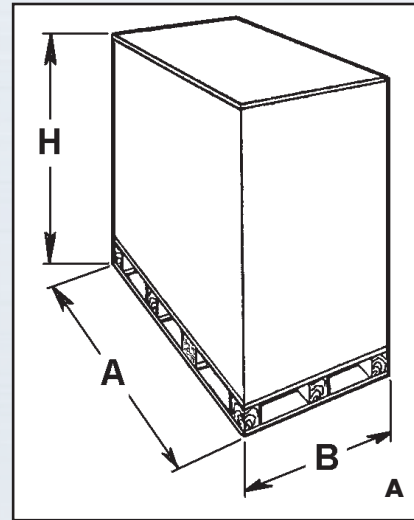

Modello	Tipo Imballo	Dimensioni (cm.) (A x B x H)	Peso Netto(kg)	Peso Lordo (kg)
SMONTAGOMME LEGGERI				
Serie M 54	Cassa in legno (A)	115x195x100	225	295
Serie M 54 LL	Cassa in legno (A)	115x195x100	225	295
Serie M 51	"	125x108x110	245	285
M 31	"	105x81x99	180	205

Modello	Tipo Imballo	Dimensioni (cm.) (A x B x H)	Peso Netto(kg)	Peso Lordo (kg)
EQUILIBRATICI				
B 75 Truck	Cassa in legno (A)	165x90x120	235	300
B 60	"	58x92x116	96	115
B 55	"	58x92x116	96	115

CONDIZIONI GENERALI DI VENDITA

- Il presente Listino Prezzi ITALIA copre le apparecchiature di produzione standard e annulla e sostituisce tutti i precedenti.
- I materiali sono resi FRANCO DOMICILIO DESTINATARIO con assicurazione coperta dal mittente.
- L'imballo standard è incluso nel prezzo di ogni prodotto.
- Al momento dell'ordinazione, indicare sempre il modello, la quantità, l'alimentazione (V, PH, Hz) richiesta.
- Condizioni di garanzia: 12 mesi dalla data di installazione, ma non più di 18 mesi dalla data della fattura di NEXION S.p.A.
- La garanzia non copre difetti o danni dovuti a installazione o utilizzo impropri dei prodotti, manutenzione inadeguata o conoscenza incompleta dei manuali forniti con i prodotti stessi.
- Qualsiasi restituzione della merce deve essere sempre autorizzata da NEXION S.p.A. Il trasporto merci è a rischio del mittente.
- NEXION S.p.A. si riserva il diritto di modificare le specifiche dei prodotti in qualsiasi momento senza preavviso o obbligo.

AVVISO!

Per altre condizioni, fare riferimento al "Contratto di distribuzione".

Bravo

LINE



**AZIENDA CON
SISTEMA DI QUALITA'
CERTIFICATO
- ISO 9001-**

